

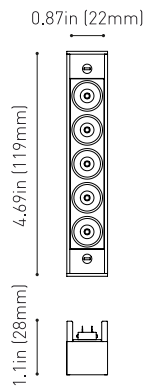

DIMENSIONS



ACCESORIES



MINIMAL TRACK OPTIONS

AWARDS



reddot winner 2020
innovative product



reddot winner 2020
lighting design



Bronze Delta
ADI Awards 2020



HONORABLE MENTION
EUROPEAN
PRODUCT
DESIGN
AWARD



WINNER
2020



archiproducts
DESIGN AWARDS
WINNER 2020

PRODUCT

Reference U4152010N

Color Matt black

Category TRACKLIGHTS

LIGHT SOURCE

Type LED

Gross luminous flux 775 Lm

Color temperature 2700 K

Chromatic stability MacAdam Step 3

Color Rendering Index CRI>90

Power 7 W

Current 500 mA

Efficacy 111 Lm/W

LED lifespan L90B10 >60.000h

LIGHTING FIXTURE | PHOTOMETRIC DATA

Lighting efficiency 0,87

Delivered luminous flux 0 Lm

Light beam angle 37°

LIGHTING FIXTURE | ELECTRICAL DATA

Driver Included

Power values of the system 7,60 W

Dimming No Dim

OTHER DATA

DRY

Track type Minimal Track

Weight 0.18 lb | 80 gr

Packaged weight 0.20 lb | 91.1 gr

Packaging dimensions 5.28x1.46x1.38 in | 134x37x35 mm

Materials Aluminium / Acrylonitrile Butadiene Styrene



Black Foster Micro 24V for Minimal Track, the most compact downlight with "The Invisible Black" effect. This linear luminaire has an excellent control of the light beam whose rays do not bathe the luminaire and are channelled directly to the exterior without touching the screen. Furthermore, its reduced design enables an absolutely perfect installation of the modules into systems.

POLAR DIAGRAM

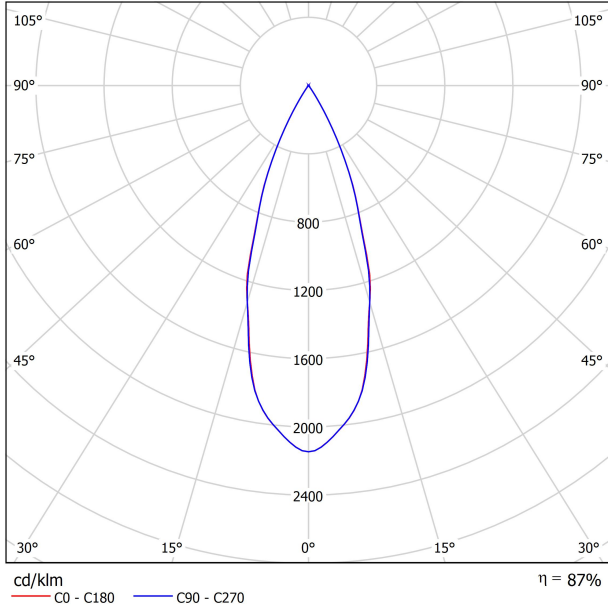

CONICAL DIAGRAM

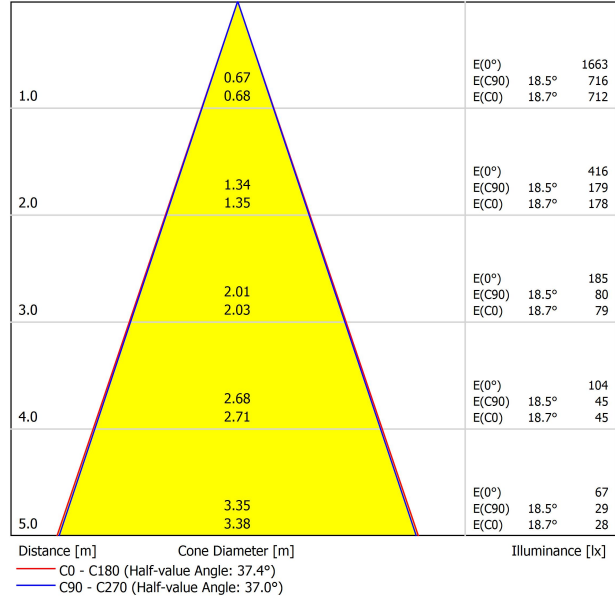

UGR

Glare Evaluation According to UGR											
ρ Ceiling	70	70	50	50	30	70	70	50	50	30	30
ρ Walls	50	30	50	30	30	50	30	50	30	30	30
ρ Floor	20	20	20	20	20	20	20	20	20	20	20
Room Size X Y		Viewing direction at right angles to lamp axis					Viewing direction parallel to lamp axis				
2H	2H	0.9	1.5	1.1	1.7	1.9	0.5	1.2	0.8	1.4	1.6
	3H	4.2	4.8	4.5	5.0	5.2	3.9	4.5	4.2	4.7	5.0
	4H	6.0	6.6	6.3	6.8	7.1	5.8	6.3	6.1	6.6	6.8
	6H	7.9	8.4	8.2	8.7	9.0	7.9	8.4	8.2	8.7	9.0
	8H	9.2	9.6	9.5	9.9	10.2	9.0	9.5	9.4	9.8	10.1
4H	2H	1.8	2.4	2.1	2.6	2.9	1.6	2.2	1.9	2.4	2.7
	3H	5.3	5.8	5.7	6.1	6.4	5.2	5.7	5.6	6.0	6.3
	4H	7.4	7.8	7.7	8.1	8.4	7.2	7.6	7.5	7.9	8.2
	6H	9.5	9.8	9.9	10.2	10.6	9.5	9.8	9.9	10.2	10.6
	8H	10.8	11.1	11.3	11.5	11.9	10.8	11.0	11.2	11.4	11.8
8H	2H	12.4	12.6	12.8	13.0	13.4	12.3	12.5	12.7	12.9	13.4
	4H	8.2	8.5	8.6	8.8	9.2	8.0	8.3	8.4	8.7	9.1
	6H	10.6	10.8	11.1	11.2	11.7	10.6	10.8	11.1	11.2	11.7
	8H	12.1	12.3	12.6	12.7	13.2	12.0	12.2	12.5	12.7	13.1
	12H	13.8	14.0	14.3	14.5	14.9	13.8	13.9	14.3	14.4	14.9
12H	4H	8.4	8.7	8.8	9.1	9.5	8.3	8.5	8.7	8.9	9.3
	6H	10.9	11.1	11.4	11.6	12.0	10.9	11.1	11.4	11.6	12.0
	8H	12.6	12.7	13.0	13.2	13.7	12.5	12.6	13.0	13.1	13.6
Variation of the observer position for the luminaire distances S											
S = 1.0H	+3.5 / -1.3					+3.6 / -1.3					
S = 1.5H	+6.0 / -1.6					+6.0 / -1.6					
S = 2.0H	+8.0 / -1.7					+8.0 / -1.9					
Standard table Correction Summand	---					---					
Corrected Glare Indices referring to 775lm Total Luminous Flux											

24V SYSTEM

MINIMAL TRACK

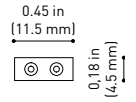
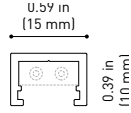
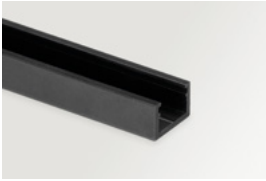

MINIMAL TRACK 24V Profile 2m UL U384-02-00- | N |

2m = 78.74in

MINIMAL TRACK 24V Rubber Cable n x 1m UL U384-00-01- | N |

n = Total Length of System
1m = 39.37in

24V | Max. 4A

MINIMAL TRACK 24V Corner 90° 1 Plane UL

U384-00-02- | N |

Cable Length = 1.38in (35mm)

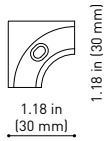

MINIMAL TRACK 24V Corner 90° 1 Plane Rounded UL

U384-00-03- | N |

Cable Length = 1.38in (35mm)

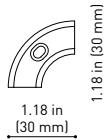

MINIMAL TRACK 24V Corner 90° 2 Planes UL

Cable Length = 3.94in (100mm)

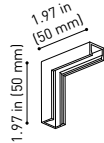

MINIMAL TRACK 24V End Cap UL

U384-00-05- | N |



MINIMAL TRACK 24V Connection Box UL

U384-00-06- | N |

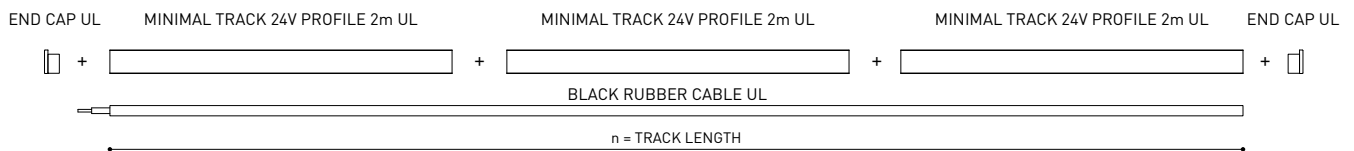
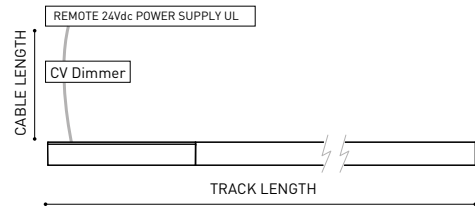
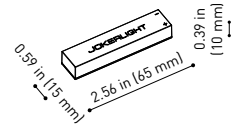

COLOUR | N ■ |

DIM OPTIONS PLEASE CONSULT

INSTALLATION GUIDE
<https://youtu.be/AqTIsTcSoGA>



24V SYSTEM

MINIMAL TRACK SUSPENSION

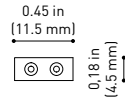
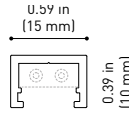
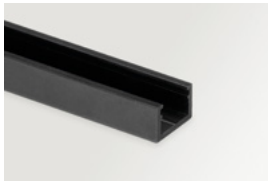

MINIMAL TRACK 24V Suspension UL

Profile 2m

U384-02-00- | N |

Profile 2m Initial feed kit UL

U400-02-10- | N |

Profile 2m Middle feed kit UL*

U400-02-20- | N |

* Unidirectional Middle Feed
2m = 78.74in

MINIMAL TRACK 24V Suspension Corner 90° UL

U400-00-03- | N |

Cable Length = 3.35in (85mm)

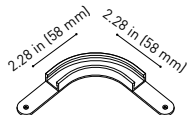
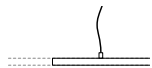
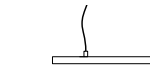

MINIMAL TRACK 24V Suspension UL

Rubber Cable n x 1m UL

U400-00-01- | N |

n = Total Length of System
1m = 39.37in

24V | Max. 4A

MINIMAL TRACK 24V Suspension Straight Joiner UL

U400-00-02- | N |

MINIMAL TRACK 24V Suspension Kit UL

U400-02-04- | N |

MINIMAL TRACK 24V Suspension End Caps UL

U400-00-05- | N |

Two End Caps Included

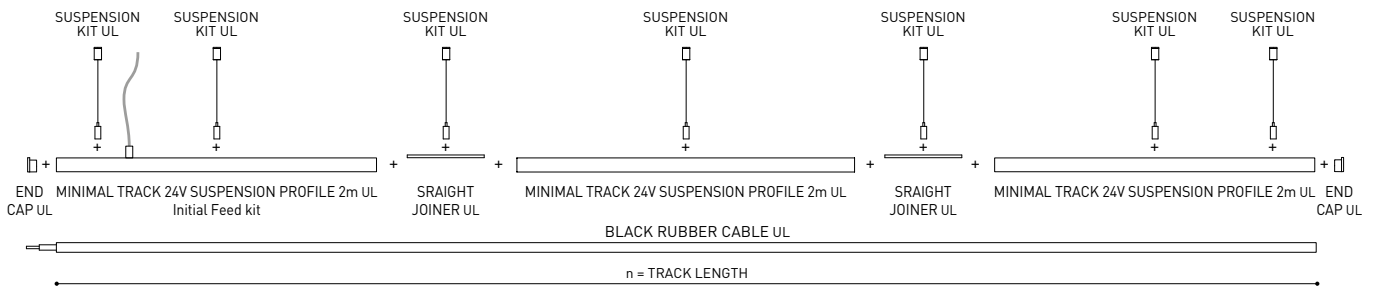
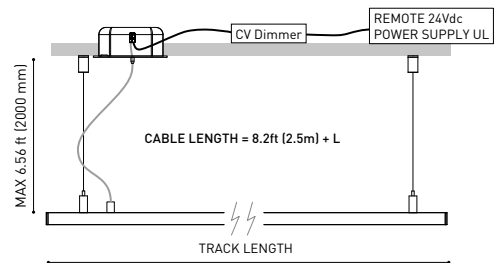
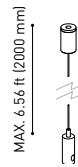
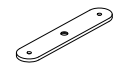

COLOUR | N ■ |

DIM OPTIONS PLEASE CONSULT

24V SYSTEM

MINIMAL TRACK SURFACE & SUSPENSION

	P	V	D (A x B x C)	
MINIMAL TRACK 24V Remote Power Supply UL	U384-00-07	100W	24V	8.16 x 2.97 x 1.30 in 207.2 x 75.4 x 33 mm

120 & 277 V | 50/60 Hz | NO DIM

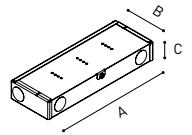

	P	V	D (A x B x C)	
MINIMAL TRACK 24V Dimmable Power Supply UL*	U010-00-01	60W	24V	5.83 x 1.68 x 1 in 148.2 x 42.6 x 25.4 mm
	U010-00-02	100W	24V	9.5 x 1.57 x 1 in 241.3 x 39.9 x 25.4 mm

120 & 277 V | 50/60 Hz | 0-10 V

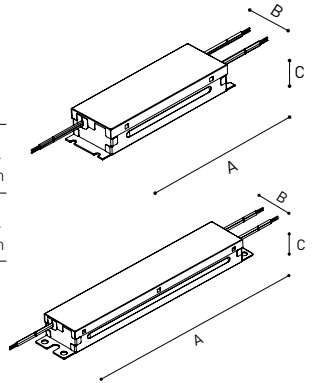

	P	V	D (A x B x C)	
MINIMAL TRACK 24V Constant Voltage Dimmer	U010-00-00	144W	24V	2.86 x 1.18 x 0.71 in 72.6 x 30 x 18 mm

24 V | CASAMBI

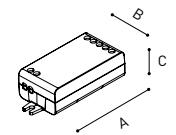

UL DROP VOLTAGE TABLE

POWER	CABLE SECTION	CABLE LENGTH			
		<16.40 ft <5 m	<32.80 ft <10 m	<65.62 ft <20 m	<98.43 ft <30 m
60 W	AWG18	98.43 ft 30 m	98.43 ft 30 m	65.62 ft 20 m	32.80 ft 10 m
	AWG16	98.43 ft 30 m	98.43 ft 30 m	98.43 ft 30 m	65.62 ft 20 m
96 W	AWG18	65.62 ft 20 m	32.80 ft 10 m	X	X
	AWG16	65.62 ft 20 m	65.62 ft 20 m	32.80 ft 10 m	X

PHASE CUT AND DMX DIM OPTIONS PLEASE CONSLT | *POWER SUPPLY REQUIRES AN ENCLOSURE FOR INSTALLATION. ENCLOSURE NOT PROVIDED