

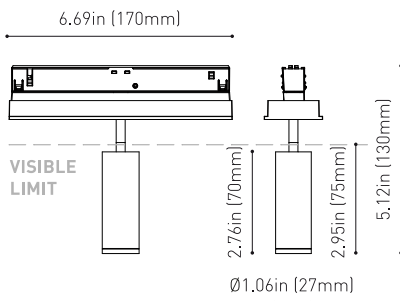

DIMENSIONS



ACCESORIES



BLACK FOSTER CUSTOM
ACCESSORIES

PRODUCT

Name	BLACK FOSTER CUSTOM MODULE FIT 27 UL 22° DIM DALI 4000K G
Reference	U4540212G
Color	Gold
Category	CUSTOM SYSTEMS

LIGHT SOURCE

Type	LED
Gross luminous flux	600 Lm
Color temperature	4000 K
Chromatic stability	MacAdam Step 2
Color Rendering Index	CRI > 90
Power	5.5 W
Current	500 mA
Efficacy	109 Lm/W
LED lifespan	L90B10 > 108.000h

LIGHTING FIXTURE | PHOTOMETRIC DATA

Lighting efficiency	84%
Delivered luminous flux	504 Lm
Light beam angle	18°

LIGHTING FIXTURE | ELECTRICAL DATA

Driver	Included
Power values of the system	7,00 W
Dimming	DALI

OTHER DATA

Environmental location	DAMP
Swivel angle	90°
Rotation angle	355°
Track type	Black Foster Custom Surface Track
Weight	0.35 lb 160 gr
Packaged weight	0.47 lb 217 gr
Packaging dimensions	8.27x4.41x2.13 in 210x112x54 mm
Materials	Aluminium / Polycarbonate



Fit 27 is a projector for the Black Foster custom system. Cylindrical geometry and essential forms, it stands out for its minimalistic looking and its functionality as it can be orientated in any direction. The black perimeter around its mouth highlights its anti-glare vocation.

POLAR DIAGRAM

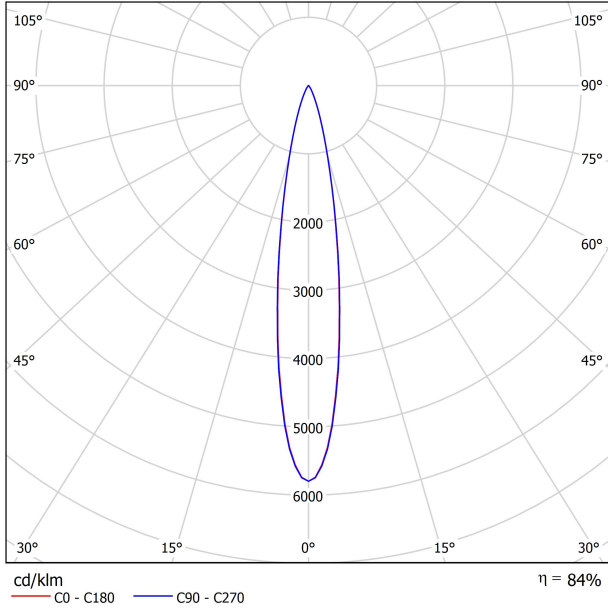

CONICAL DIAGRAM



UGR

Glare Evaluation According to UGR											
ρ Ceiling	70	70	50	50	30	70	70	50	50	30	30
ρ Walls	50	30	50	30	30	50	30	50	30	30	30
ρ Floor	20	20	20	20	20	20	20	20	20	20	20
Room Size X Y		Viewing direction at right angles to lamp axis					Viewing direction parallel to lamp axis				
2H	2H	11.6	12.3	11.9	12.5	12.7	11.7	12.4	12.0	12.6	12.8
	3H	12.9	13.5	13.2	13.8	14.0	13.2	13.8	13.5	14.1	14.3
	4H	14.0	14.6	14.3	14.8	15.1	14.1	14.7	14.4	15.0	15.2
	6H	15.0	15.5	15.3	15.8	16.1	15.0	15.6	15.4	15.8	16.1
	8H	15.6	16.1	16.0	16.4	16.7	15.6	16.1	15.9	16.4	16.7
	12H	16.5	16.9	16.8	17.2	17.6	16.5	17.0	16.8	17.3	17.6
4H	2H	12.1	12.7	12.4	12.9	13.2	12.2	12.8	12.5	13.0	13.3
	3H	13.7	14.2	14.1	14.5	14.8	14.0	14.5	14.3	14.8	15.1
	4H	15.0	15.4	15.4	15.8	16.1	15.1	15.5	15.4	15.8	16.2
	6H	16.2	16.6	16.6	16.9	17.3	16.2	16.6	16.6	16.9	17.3
	8H	17.0	17.3	17.4	17.7	18.1	16.9	17.2	17.4	17.6	18.0
	12H	18.0	18.3	18.4	18.7	19.1	18.0	18.3	18.4	18.7	19.1
8H	4H	15.5	15.8	15.9	16.1	16.5	15.5	15.8	15.9	16.2	16.6
	6H	17.0	17.2	17.4	17.6	18.1	17.0	17.2	17.4	17.6	18.1
	8H	18.0	18.2	18.5	18.6	19.1	17.9	18.1	18.4	18.5	19.0
	12H	19.2	19.4	19.7	19.9	20.3	19.2	19.4	19.7	19.8	20.3
12H	4H	15.6	15.8	16.0	16.2	16.7	15.6	15.9	16.1	16.3	16.7
	6H	17.2	17.4	17.7	17.9	18.3	17.2	17.4	17.7	17.9	18.3
	8H	18.3	18.5	18.8	19.0	19.5	18.3	18.4	18.8	18.9	19.4
Variation of the observer position for the luminaire distances S											
S = 1.0H	+1.3 / -0.6					+1.3 / -0.5					
S = 1.5H	+2.8 / -0.8					+2.7 / -0.8					
S = 2.0H	+4.3 / -1.3					+4.2 / -1.2					
Standard table Correction Summand	---					---					
Corrected Glare Indices referring to 640lm Total Luminous Flux											

BLACK FOSTER CUSTOM UL



BLACK FOSTER CUSTOM SURFACE	3.28ft (1m) UL	U452-01-00-	NT	WT
BLACK FOSTER CUSTOM SURFACE	6.56ft (2m) UL	U452-02-00-	NT	WT

BLACK FOSTER CUSTOM COVER	Gap 250 UL	U452-00-01-	N	9.84 in / 250 mm
BLACK FOSTER CUSTOM COVER	Gap 500 UL	U452-00-02-	N	16.69 in / 500 mm

L



BLACK FOSTER CUSTOM SURFACE	L-Joint UL	U452-04-00-	NT	WT
BLACK FOSTER CUSTOM SURFACE	T-Joint UL	U452-05-00-	NT	WT
BLACK FOSTER CUSTOM SURFACE	X-Joint UL	U452-06-00-	NT	WT

BLACK FOSTER CUSTOM SURFACE L-Joint UL



Electrical connection not included

BLACK FOSTER CUSTOM SURFACE T-Joint UL



Electrical connection not included

BLACK FOSTER CUSTOM SURFACE X-Joint UL



Electrical connection not included

P V D

CONSTANT VOLTAGE	U100-00-78	96 W	48 V	8.16 x 2.97 x 1.30 in
LED POWER SUPPLY				207 x 75.4 x 33 mm

120 & 277V | 50/60 Hz



UL DROP VOLTAGE TABLE

POWER	CABLE SECTION	CABLE LENGTH			
		16.40ft 5m	32.80ft 10m	65.62ft 20m	98.43ft 30m
96 W	AWG16	TRACK LENGTH			
		164ft 50m	164ft 50m	131.32ft 40m	82ft 25m

COLOUR | N ■ | NT ■ | WT □ |

BLACK FOSTER CUSTOM UL

BLACK FOSTER CUSTOM TRACK COMPONENTS



BLACK FOSTER CUSTOM SURFACE
End UL U452-00-03- | N | W |

Cover thickness = 0.12in (3mm)



BLACK FOSTER CUSTOM SURFACE
End Feed UL U452-00-04- | N | W |

Cover thickness = 0.12in (3mm)



BLACK FOSTER CUSTOM SURFACE
Straight Joiner UL U452-00-05

CONNECTION COMPONENTS



Live-End Connector 48V UL
 U338-00-01- | N |



L-Joint Connector 48V UL
 U338-00-12- | N |



Central Connector 48V UL
 U338-00-02- | N |



T-Joint Connector 48V UL
 U450-00-07- | N |



X-Joint Connector 48V UL
 U450-00-08- | N |

SUSPENSION COMPONENTS



Black Foster Suspension Kit (2 Units) UL
 U450-00-09- | NT | WT |

Suggested Mounting accessories quantities
 3.28ft (1000mm) - 2 Pcs.
 6.56ft (2000mm) - 3 Pcs.



Suspension Feed Kit 48V UL
 U338-00-17- | N | W |



*For remote power supply