

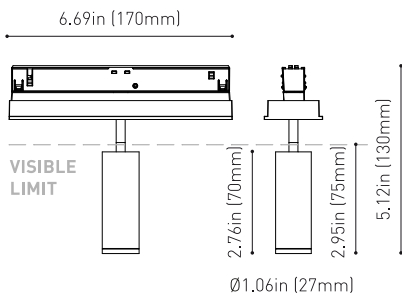

DIMENSIONS



ACCESSORIES



BLACK FOSTER CUSTOM
ACCESSORIES

Reference

U4540130WT

Color

Textured white

Category

CUSTOM SYSTEMS

Type

LED

Gross luminous flux

520 Lm

Color temperature

2700 K

Chromatic stability

MacAdam Step 2

Color Rendering Index

CRI>90

Power

5.5 W

Current

500 mA

Efficacy

94 Lm/W

LED lifespan

L90B10>108.000h

LIGHT SOURCE

LIGHTING FIXTURE | PHOTOMETRIC DATA

Lighting efficiency

84%

Delivered luminous flux

437 Lm

Light beam angle

42°

LIGHTING FIXTURE | ELECTRICAL DATA

Driver

Included

Power values of the system

7,00 W

Dimming

0-10V

OTHER DATA

Environmental location

DAMP

Swivel angle

90°

Rotation angle

355°

Track type

Black Foster Custom Surface Track

Weight

0.35 lb | 160 gr

Packaged weight

0.47 lb | 217 gr

Packaging dimensions

8.27x4.41x2.13 in | 210x112x54 mm

Materials

Aluminium / Polycarbonate



Fit 27 is a projector for the Black Foster custom system. Cylindrical geometry and essential forms, it stands out for its minimalistic looking and its functionality as it can be orientated in any direction. The black perimeter around its mouth highlights its anti-glare vocation.

POLAR DIAGRAM

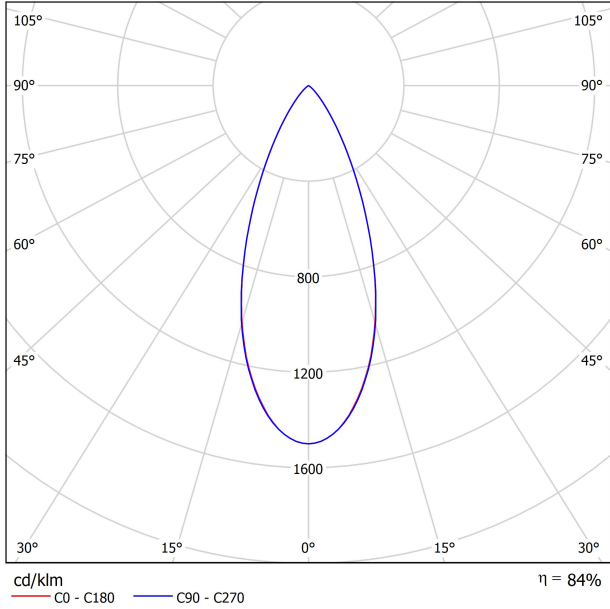

CONICAL DIAGRAM



UGR

Glare Evaluation According to UGR											
ρ Ceiling	70	70	50	50	30	70	70	50	50	30	
ρ Walls	50	30	50	30	30	50	30	50	30	30	
ρ Floor	20	20	20	20	20	20	20	20	20	20	
Room Size X Y	Viewing direction at right angles to lamp axis					Viewing direction parallel to lamp axis					
2H	2H	12.6	13.3	12.8	13.5	13.7	13.0	13.7	13.3	13.9	14.1
	3H	12.7	13.4	13.0	13.6	13.8	13.1	13.8	13.4	14.0	14.2
	4H	12.9	13.5	13.2	13.8	14.0	13.3	13.9	13.6	14.1	14.4
	6H	13.1	13.7	13.5	14.0	14.3	13.5	14.0	13.8	14.3	14.6
	8H	13.3	13.8	13.6	14.1	14.4	13.6	14.1	13.9	14.4	14.7
4H	12H	13.6	14.1	13.9	14.4	14.7	13.9	14.4	14.2	14.7	15.0
	2H	12.5	13.1	12.8	13.4	13.7	13.0	13.6	13.3	13.8	14.1
	3H	12.8	13.3	13.1	13.6	13.9	13.2	13.7	13.5	14.0	14.3
	4H	13.1	13.5	13.4	13.8	14.2	13.4	13.8	13.8	14.2	14.5
	6H	13.5	13.9	13.9	14.2	14.6	13.7	14.1	14.1	14.5	14.9
8H	8H	13.8	14.1	14.2	14.5	14.9	14.0	14.3	14.4	14.7	15.1
	12H	14.2	14.5	14.6	14.9	15.3	14.4	14.7	14.9	15.1	15.5
	4H	13.2	13.5	13.6	13.9	14.3	13.5	13.8	13.9	14.2	14.6
	6H	13.8	14.0	14.2	14.4	14.9	14.0	14.2	14.4	14.6	15.1
	8H	14.2	14.4	14.6	14.8	15.3	14.4	14.6	14.8	15.0	15.5
12H	12H	14.8	14.9	15.3	15.4	15.9	15.0	15.1	15.5	15.6	16.1
	4H	13.2	13.4	13.6	13.8	14.3	13.5	13.8	13.9	14.2	14.6
	6H	13.8	14.0	14.3	14.5	15.0	14.0	14.3	14.5	14.7	15.2
	8H	14.3	14.5	14.8	14.9	15.4	14.5	14.7	15.0	15.1	15.6
	Variation of the observer position for the luminaire distances S										
S = 1.0H	+3.8 / -6.3					+3.8 / -6.2					
S = 1.5H	+6.5 / -9.2					+6.5 / -9.1					
S = 2.0H	+8.5 / -10.3					+8.5 / -10.2					
Standard table	BK00					BK00					
Correction Summand	5.7					5.7					
Corrected Glare Indices referring to 550lm Total Luminous Flux											

BLACK FOSTER CUSTOM UL



BLACK FOSTER CUSTOM SURFACE	3.28ft (1m) UL	U452-01-00-	NT	WT
BLACK FOSTER CUSTOM SURFACE	6.56ft (2m) UL	U452-02-00-	NT	WT

BLACK FOSTER CUSTOM COVER	Gap 250 UL	U452-00-01-	N	9.84 in / 250 mm
BLACK FOSTER CUSTOM COVER	Gap 500 UL	U452-00-02-	N	16.69 in / 500 mm

L

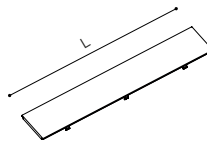

BLACK FOSTER CUSTOM SURFACE	L-Joint UL	U452-04-00-	NT	WT
BLACK FOSTER CUSTOM SURFACE	T-Joint UL	U452-05-00-	NT	WT
BLACK FOSTER CUSTOM SURFACE	X-Joint UL	U452-06-00-	NT	WT

BLACK FOSTER CUSTOM SURFACE
L-Joint UL

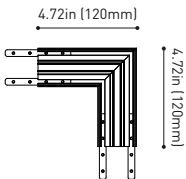

Electrical connection not included

BLACK FOSTER CUSTOM SURFACE
T-Joint UL

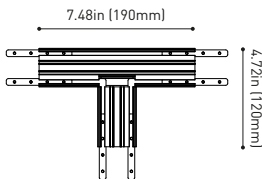

Electrical connection not included

BLACK FOSTER CUSTOM SURFACE
X-Joint UL

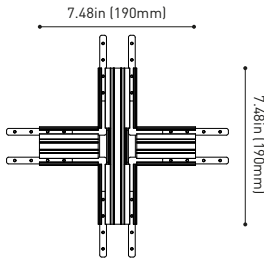

Electrical connection not included

P V D

CONSTANT VOLTAGE	U100-00-78	96 W	48 V	8.16 x 2.97 x 1.30 in
LED POWER SUPPLY				207 x 75.4 x 33 mm

120 & 277V | 50/60 Hz

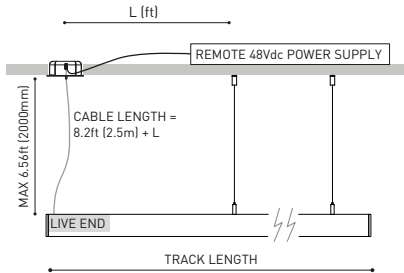
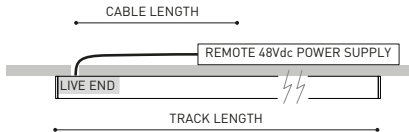

UL DROP
VOLTAGE TABLE

POWER	CABLE SECTION	CABLE LENGTH			
		16.40ft 5m	32.80ft 10m	65.62ft 20m	98.43ft 30m
96 W	AWG16	TRACK LENGTH			
		164ft 50m	164ft 50m	131.32ft 40m	82ft 25m

COLOUR | N ■ | NT ■ | WT □ |

BLACK FOSTER CUSTOM UL

BLACK FOSTER CUSTOM TRACK COMPONENTS



BLACK FOSTER CUSTOM SURFACE
End UL U452-00-03- | N | W |

Cover thickness = 0.12in (3mm)



BLACK FOSTER CUSTOM SURFACE
End Feed UL U452-00-04- | N | W |

Cover thickness = 0.12in (3mm)



BLACK FOSTER CUSTOM SURFACE
Straight Joiner UL U452-00-05

CONNECTION COMPONENTS

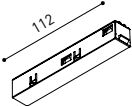

Live-End Connector 48V UL
 U338-00-01- | N |

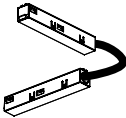

L-Joint Connector 48V UL
 U338-00-12- | N |

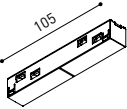

Central Connector 48V UL
 U338-00-02- | N |

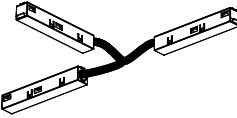

T-Joint Connector 48V UL
 U450-00-07- | N |

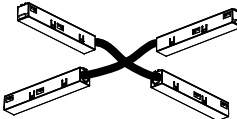

X-Joint Connector 48V UL
 U450-00-08- | N |

SUSPENSION COMPONENTS

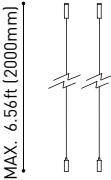

Black Foster Suspension Kit (2 Units) UL
 U450-00-09- | NT | WT |

Suggested Mounting accessories quantities
 3.28ft (1000mm) - 2 Pcs.
 6.56ft (2000mm) - 3 Pcs.

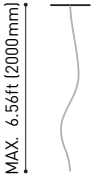

Suspension Feed Kit 48V UL
 U338-00-17- | N | W |



*For remote power supply