

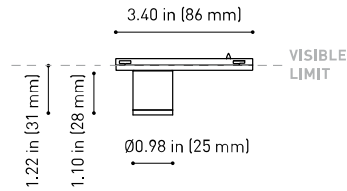

DIMENSIONS



ACCESORIES



MINIMAL TRACK OPTIONS

AWARDS



reddot winner 2020  
innovative product



reddot winner 2020  
lighting design



Bronze Delta  
ADI Awards 2020



HONORABLE MENTION  
EUROPEAN  
PRODUCT  
DESIGN  
AWARD



WINNER  
2020



WINNER 2020

Name	TOP MICRO 24V UL 38° 2700K WT
Reference	U3830020WT
Color	Textured white
Category	TRACKLIGHTS

PRODUCT

Type	LED
Gross luminous flux	190 Lm
Color temperature	2700 K
Chromatic stability	MacAdam Step 3
Color Rendering Index	CRI>90
Power	2.1 W
Current	700 mA
Efficacy	90 Lm/W
LED lifespan	L90B10>102.000h

LIGHT SOURCE

Lighting efficiency	92%
Delivered luminous flux	175 Lm
Light beam angle	38°

LIGHTING FIXTURE | PHOTOMETRIC DATA

Driver	Included
Power values of the system	2,80 W
Dimming	No Dim

LIGHTING FIXTURE | ELECTRICAL DATA

Environmental location	DRY
Track type	Minimal Track
Weight	0.06 lb   25 gr
Packaged weight	0.07 lb   30 gr
Packaging dimensions	4.41x3.03x1.34 in   112x77x34 mm
Materials	Aluminium / Polycarbonate

OTHER DATA



Top Micro 24V is miniaturized luminary that serves as a downlight for the Minimal Track system. Its reduced dimensions make Top the perfect candidate for projects where a discrete presence and a perfect integration are needed. It is a pure line and an architectural aesthetic design. Moreover, in terms of lighting performance, Top offers a conical distribution with two possible beam angles.



POLAR DIAGRAM

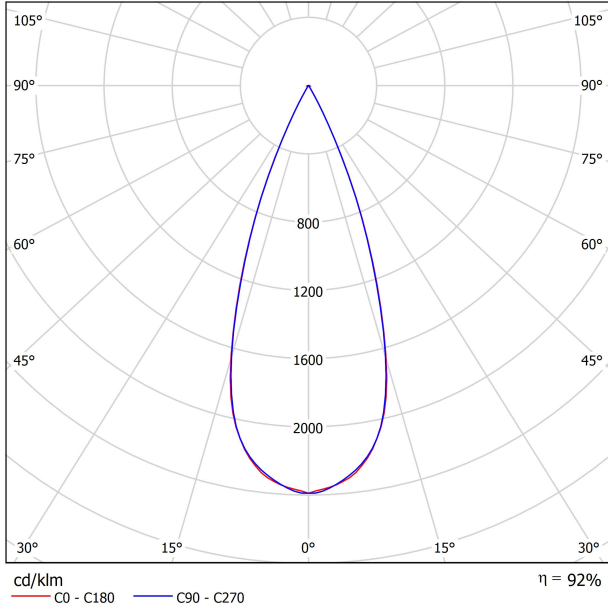

CONICAL DIAGRAM

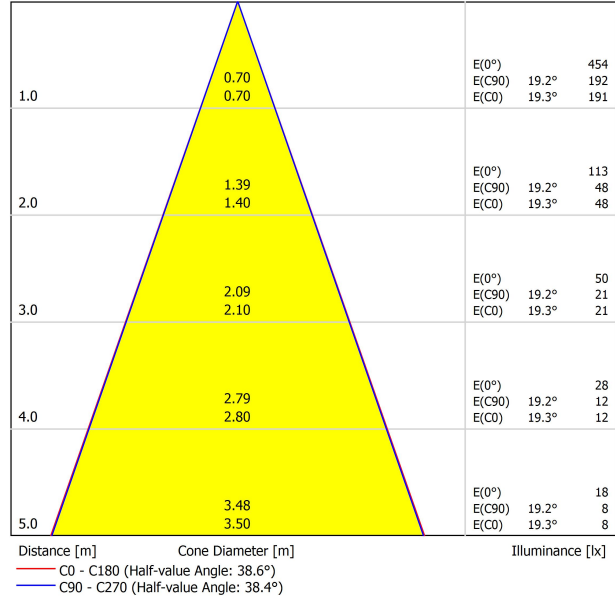

UGR

Glare Evaluation According to UGR											
ρ Ceiling		70	70	50	50	30	70	70	50	50	30
ρ Walls		50	30	50	30	30	50	30	50	30	30
ρ Floor		20	20	20	20	20	20	20	20	20	20
Room Size X Y		Viewing direction at right angles to lamp axis					Viewing direction parallel to lamp axis				
2H	2H	-2.7	-2.0	-2.4	-1.8	-1.6	-2.5	-1.9	-2.3	-1.7	-1.5
	3H	1.1	1.7	1.4	1.9	2.2	1.0	1.5	1.2	1.8	2.0
	4H	2.9	3.5	3.2	3.7	4.0	3.1	3.6	3.4	3.9	4.1
	6H	5.1	5.6	5.4	5.9	6.1	5.4	5.9	5.7	6.2	6.4
	8H	6.4	6.9	6.7	7.2	7.5	6.5	7.0	6.9	7.3	7.6
4H	12H	7.7	8.2	8.1	8.5	8.8	7.9	8.3	8.2	8.6	9.0
	2H	-1.5	-1.0	-1.2	-0.7	-0.5	-1.4	-0.9	-1.1	-0.6	-0.3
	3H	2.3	2.8	2.7	3.1	3.4	2.4	2.8	2.7	3.1	3.4
	4H	4.4	4.8	4.8	5.1	5.5	4.6	5.0	5.0	5.3	5.7
	6H	6.7	7.0	7.1	7.4	7.8	7.0	7.4	7.4	7.7	8.1
8H	8H	8.1	8.4	8.5	8.8	9.2	8.3	8.6	8.7	9.0	9.4
	12H	9.6	9.8	10.0	10.2	10.7	9.8	10.0	10.2	10.4	10.8
	4H	5.4	5.7	5.8	6.0	6.4	5.5	5.8	5.9	6.2	6.6
	6H	7.9	8.1	8.4	8.6	9.0	8.1	8.4	8.6	8.8	9.2
	8H	9.5	9.6	9.9	10.1	10.6	9.6	9.8	10.0	10.2	10.7
12H	12H	11.1	11.3	11.6	11.7	12.2	11.2	11.4	11.7	11.8	12.3
	4H	5.6	5.9	6.1	6.3	6.7	5.8	6.0	6.2	6.4	6.8
	6H	8.3	8.5	8.7	8.9	9.4	8.5	8.6	8.9	9.1	9.6
8H	9.9	10.1	10.4	10.5	11.0	10.0	10.2	10.5	10.6	11.1	
Variation of the observer position for the luminaire distances S											
S = 1.0H		+0.4 / -0.2					+0.4 / -0.2				
S = 1.5H		+0.9 / -0.5					+0.9 / -0.4				
S = 2.0H		+1.6 / -0.6					+1.6 / -0.6				
Standard table Correction Summand		---					---				
Corrected Glare Indices referring to 190lm Total Luminous Flux											

24V SYSTEM

# MINIMAL TRACK

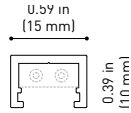
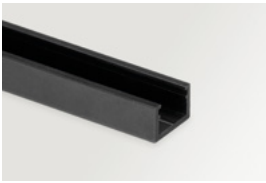

**MINIMAL TRACK 24V Profile 2m UL** U384-02-00- | N |

2m = 78.74in

**MINIMAL TRACK 24V Rubber Cable n x 1m UL** U384-00-01- | N |

n = Total Length of System  
1m = 39.37in

24V | Max. 4A

**MINIMAL TRACK 24V Corner 90° 1 Plane UL**

U384-00-02- | N |

Cable Length = 1.38in (35mm)

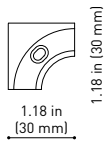

**MINIMAL TRACK 24V Corner 90° 1 Plane Rounded UL**

U384-00-03- | N |

Cable Length = 1.38in (35mm)

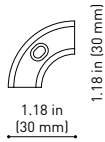

**MINIMAL TRACK 24V Corner 90° 2 Planes UL**

Cable Length = 3.94in (100mm)

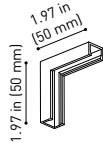

**MINIMAL TRACK 24V End Cap UL**

U384-00-05- | N |



**MINIMAL TRACK 24V Connection Box UL**

U384-00-06- | N |

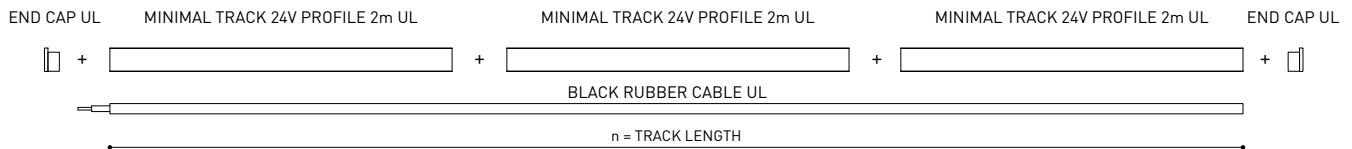
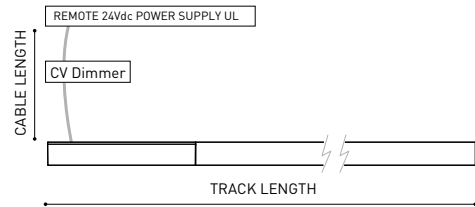

COLOUR | N ■ |

DIM OPTIONS PLEASE CONSULT

INSTALLATION GUIDE  
<https://youtu.be/AqTlsTcSoGA>



24V SYSTEM

# MINIMAL TRACK SUSPENSION

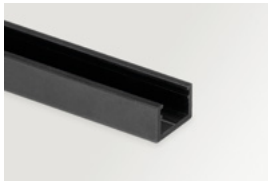

**MINIMAL TRACK 24V Suspension UL**

**Profile 2m**

U384-02-00- | N |

**Profile 2m Initial feed kit UL**

U400-02-10- | N |

**Profile 2m Middle feed kit UL\***

U400-02-20- | N |

\* Unidirectional Middle Feed  
2m = 78.74in

**MINIMAL TRACK 24V Suspension Corner 90° UL**

U400-00-03- | N |

Cable Length = 3.35in (85mm)

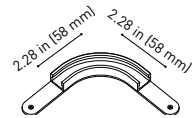
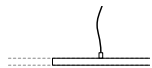
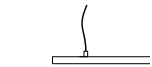

**MINIMAL TRACK 24V Suspension UL**

**Rubber Cable n x 1m UL**

U400-00-01- | N |

n = Total Length of System  
1m = 39.37in

24V | Max. 4A

**MINIMAL TRACK 24V Suspension Straight Joiner UL**

U400-00-02- | N |

**MINIMAL TRACK 24V Suspension Kit UL**

U400-02-04- | N |

**MINIMAL TRACK 24V Suspension End Caps UL**

U400-00-05- | N |

Two End Caps Included

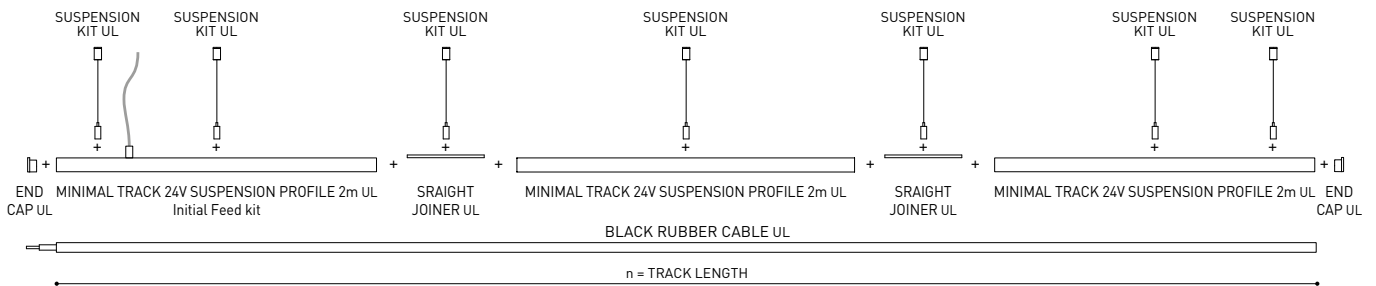
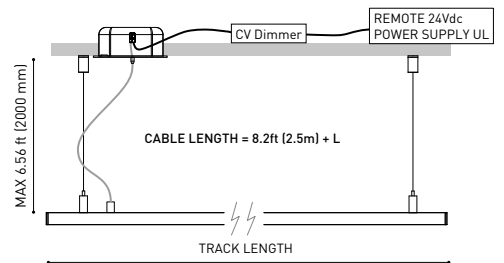
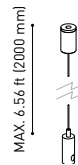

COLOUR | N ■ |

DIM OPTIONS PLEASE CONSULT

24V SYSTEM

MINIMAL TRACK SURFACE & SUSPENSION

	P	V	D (A x B x C)	
<b>MINIMAL TRACK 24V Remote Power Supply UL</b>	<b>U384-00-07</b>	100W	24V	8.16 x 2.97 x 1.30 in 207.2 x 75.4 x 33 mm

120 & 277 V | 50/60 Hz | NO DIM

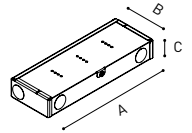

	P	V	D (A x B x C)	
<b>MINIMAL TRACK 24V Dimmable Power Supply UL*</b>	<b>U010-00-01</b>	60W	24V	5.83 x 1.68 x 1 in 148.2 x 42.6 x 25.4 mm
	<b>U010-00-02</b>	100W	24V	9.5 x 1.57 x 1 in 241.3 x 39.9 x 25.4 mm

120 & 277 V | 50/60 Hz | 0-10 V

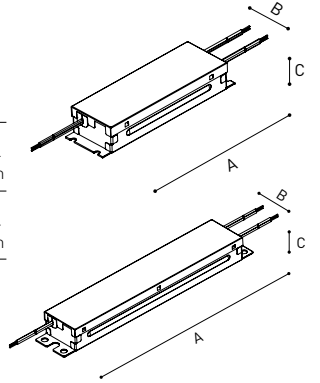

	P	V	D (A x B x C)	
<b>MINIMAL TRACK 24V Constant Voltage Dimmer</b>	<b>U010-00-00</b>	144W	24V	2.86 x 1.18 x 0.71 in 72.6 x 30 x 18 mm

24 V | CASAMBI

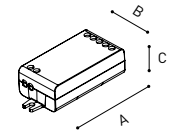

UL DROP VOLTAGE TABLE

POWER	CABLE SECTION	CABLE LENGTH			
		<16.40 ft <5 m	<32.80 ft <10 m	<65.62 ft <20 m	<98.43 ft <30 m
60 W	AWG18	98.43 ft 30 m	98.43 ft 30 m	65.62 ft 20 m	32.80 ft 10 m
	AWG16	98.43 ft 30 m	98.43 ft 30 m	98.43 ft 30 m	65.62 ft 20 m
96 W	AWG18	65.62 ft 20 m	32.80 ft 10 m	X	X
	AWG16	65.62 ft 20 m	65.62 ft 20 m	32.80 ft 10 m	X

PHASE CUT AND DMX DIM OPTIONS PLEASE CONSLT | \*POWER SUPPLY REQUIRES AN ENCLOSURE FOR INSTALLATION. ENCLOSURE NOT PROVIDED