

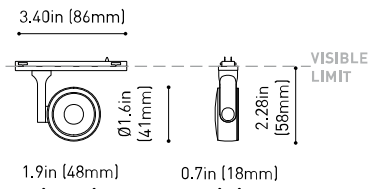

## DIMENSIONS



## ACCESSORIES



MINIMAL TRACK OPTIONS

## AWARDS

red dot winner 2020  
innovative productred dot winner 2020  
lighting designBronze Delta  
ADI Awards 2020HONORABLE MENTION  
EUROPEAN  
PRODUCT  
DESIGN  
AWARDWINNER  
2020archiproducts  
DESIGN AWARDS  
WINNER 2020

Name	SIX XS 24V UL 34° 4000K NT
Reference	U3890032NT
Color	Textured black
Category	TRACKLIGHTS

## LIGHT SOURCE

Type	LED
Gross luminous flux	450 Lm
Color temperature	4000 K
Chromatic stability	MacAdam Step 2
Color Rendering Index	CRI > 90
Power	3.5 W
Current	400 mA
Efficacy	129 Lm/W
LED lifespan	L90B10 > 55,000h

## LIGHTING FIXTURE | PHOTOMETRIC DATA

Lighting efficiency	88%
Delivered luminous flux	396 Lm
Light beam angle	34°

## LIGHTING FIXTURE | ELECTRICAL DATA

Driver	Included
Power values of the system	4,00 W
Dimming	Dim options

## OTHER DATA

Environmental location	DRY
Track type	Minimal Track
Weight	0.12 lb   55 gr
Packaged weight	0.19 lb   85 gr
Packaging dimensions	4.41x3.5x1.02 in   112x89x26 mm
Materials	Aluminium / Polycarbonate



\*\*US product only. Not available in Canada. Six XS 24V is a projector for the Minimal Track system that stands out for its lightness and elegance. Its body; disk looking, rounded shaped, encloses an innovative combination of reflector and lens. The combined action of both, allows Six to direct light rays with the maximum uniformity in a very small distance that, at the same time, has made possible its differential design-reduced and minimalist-.

POLAR DIAGRAM

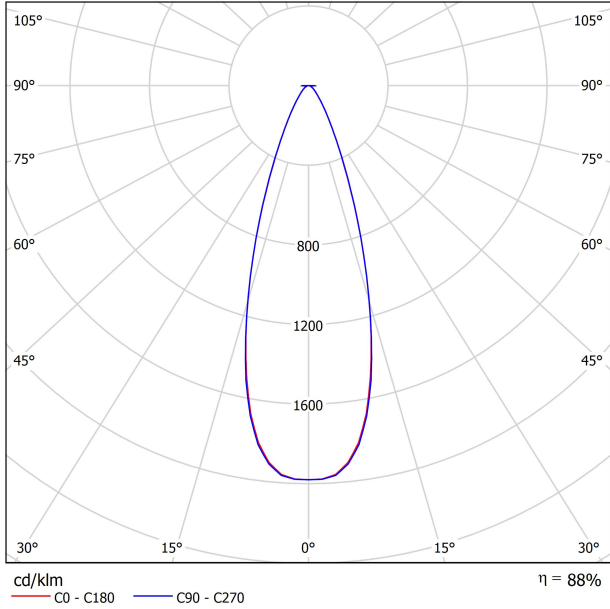

CONICAL DIAGRAM

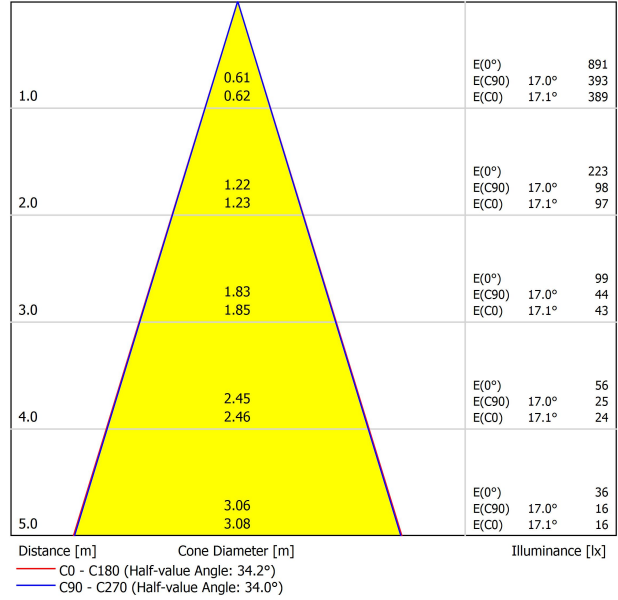

24V SYSTEM

# MINIMAL TRACK

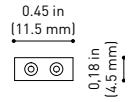
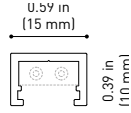
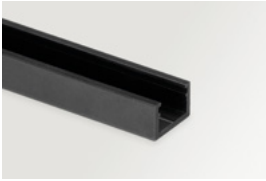

**MINIMAL TRACK 24V Profile 2m UL** U384-02-00- | N |

2m = 78.74in

**MINIMAL TRACK 24V Rubber Cable n x 1m UL** U384-00-01- | N |

n = Total Length of System  
1m = 39.37in

24V | Max. 4A

**MINIMAL TRACK 24V Corner 90° 1 Plane UL**

U384-00-02- | N |

Cable Length = 1.38in (35mm)

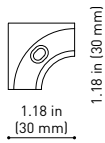

**MINIMAL TRACK 24V Corner 90° 1 Plane Rounded UL**

U384-00-03- | N |

Cable Length = 1.38in (35mm)

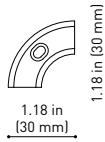

**MINIMAL TRACK 24V Corner 90° 2 Planes UL**

Cable Length = 3.94in (100mm)

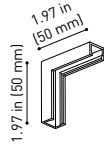

**MINIMAL TRACK 24V End Cap UL**

U384-00-05- | N |



**MINIMAL TRACK 24V Connection Box UL**

U384-00-06- | N |

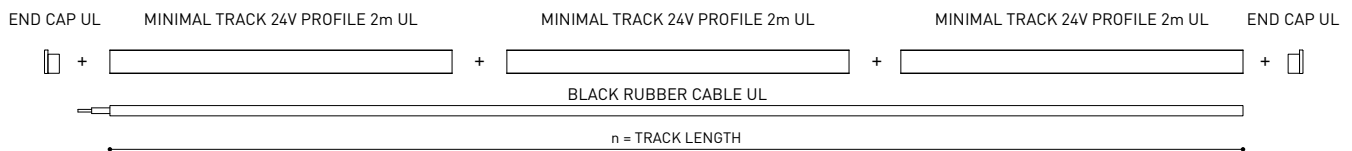
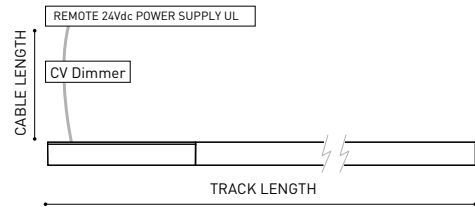
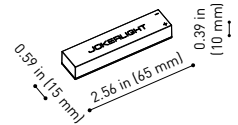

COLOUR | N ■ |

DIM OPTIONS PLEASE CONSULT

INSTALLATION GUIDE  
<https://youtu.be/AqTlsTcSoGA>



24V SYSTEM

# MINIMAL TRACK SUSPENSION

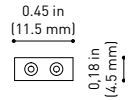
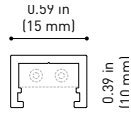
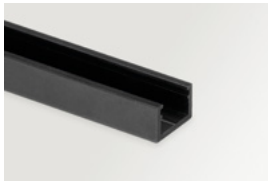

**MINIMAL TRACK 24V Suspension UL**

**Profile 2m**

U384-02-00- | N |

**Profile 2m Initial feed kit UL**

U400-02-10- | N |

**Profile 2m Middle feed kit UL\***

U400-02-20- | N |

\* Unidirectional Middle Feed  
2m = 78.74in

**MINIMAL TRACK 24V Suspension Corner 90° UL**

U400-00-03- | N |

Cable Length = 3.35in (85mm)

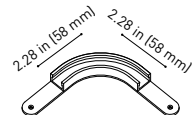
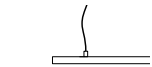

**MINIMAL TRACK 24V Suspension UL**

**Rubber Cable n x 1m UL**

U400-00-01- | N |

n = Total Length of System  
1m = 39.37in

24V | Max. 4A

**MINIMAL TRACK 24V Suspension Straight Joiner UL**

U400-00-02- | N |

**MINIMAL TRACK 24V Suspension Kit UL**

U400-02-04- | N |

**MINIMAL TRACK 24V Suspension End Caps UL**

U400-00-05- | N |

Two End Caps Included

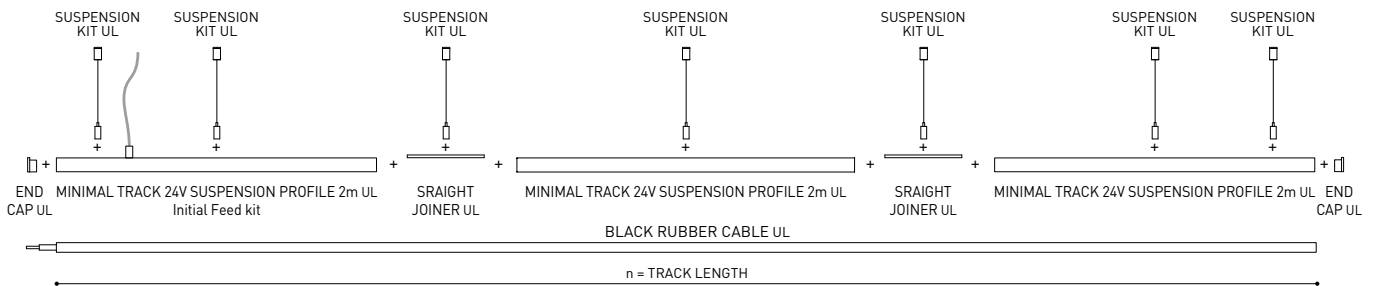
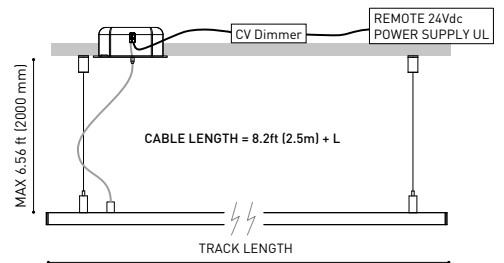
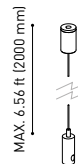
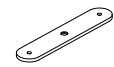

COLOUR | N ■ |

DIM OPTIONS PLEASE CONSULT

24V SYSTEM

MINIMAL TRACK SURFACE & SUSPENSION

	P	V	D (A x B x C)	
<b>MINIMAL TRACK 24V Remote Power Supply UL</b>	<b>U384-00-07</b>	100W	24V	8.16 x 2.97 x 1.30 in 207.2 x 75.4 x 33 mm

120 & 277 V | 50/60 Hz | NO DIM

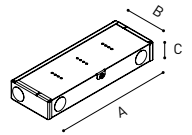

	P	V	D (A x B x C)	
<b>MINIMAL TRACK 24V Dimmable Power Supply UL*</b>	<b>U010-00-01</b>	60W	24V	5.83 x 1.68 x 1 in 148.2 x 42.6 x 25.4 mm
	<b>U010-00-02</b>	100W	24V	9.5 x 1.57 x 1 in 241.3 x 39.9 x 25.4 mm

120 & 277 V | 50/60 Hz | 0-10 V

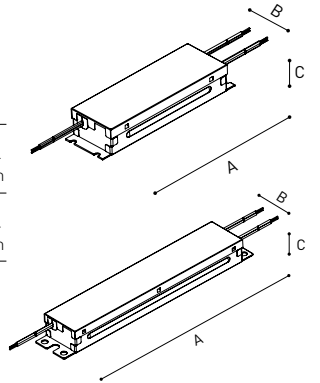

	P	V	D (A x B x C)	
<b>MINIMAL TRACK 24V Constant Voltage Dimmer</b>	<b>U010-00-00</b>	144W	24V	2.86 x 1.18 x 0.71 in 72.6 x 30 x 18 mm

24 V | CASAMBI

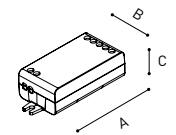

UL DROP VOLTAGE TABLE

POWER	CABLE SECTION	CABLE LENGTH			
		<16.40 ft <5 m	<32.80 ft <10 m	<65.62 ft <20 m	<98.43 ft <30 m
60 W	AWG18	98.43 ft 30 m	98.43 ft 30 m	65.62 ft 20 m	32.80 ft 10 m
	AWG16	98.43 ft 30 m	98.43 ft 30 m	98.43 ft 30 m	65.62 ft 20 m
96 W	AWG18	65.62 ft 20 m	32.80 ft 10 m	X	X
	AWG16	65.62 ft 20 m	65.62 ft 20 m	32.80 ft 10 m	X

PHASE CUT AND DMX DIM OPTIONS PLEASE CONSLT | \*POWER SUPPLY REQUIRES AN ENCLOSURE FOR INSTALLATION. ENCLOSURE NOT PROVIDED