

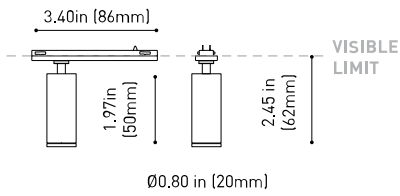

DIMENSIONS



ACCESORIES



MINIMAL TRACK OPTIONS

AWARDS



reddot winner 2020  
innovative product



reddot winner 2020  
lighting design



Bronze Delta  
ADI Awards 2020



HONORABLE MENTION  
EUROPEAN  
PRODUCT  
DESIGN  
AWARD



WINNER  
2020



archiproducts  
DESIGN AWARDS  
WINNER 2020

PRODUCT

Name	FIT 20 24V UL SPOT 2700K NT
Reference	U3860010NT
Color	Textured black
Category	TRACKLIGHTS

LIGHT SOURCE

Type	LED
Gross luminous flux	127 Lm
Color temperature	2700 K
Chromatic stability	MacAdam Step 3
Color Rendering Index	CRI>90
Power	2.1 W
Current	700 mA
Efficacy	60 Lm/W
LED lifespan	L80B10 >50.000h

LIGHTING FIXTURE | PHOTOMETRIC DATA

Lighting efficiency	87%
Delivered luminous flux	110 Lm
Light beam angle	12°

LIGHTING FIXTURE | ELECTRICAL DATA

Driver	Included
Power values of the system	2,80 W
Dimming	Dim options

OTHER DATA

Environmental location	DRY
Track type	Minimal Track
Weight	0.10 lb   45 gr
Packaged weight	0.17 lb   75 gr
Packaging dimensions	4.41x3.54x1.02 in   112x90x26 mm
Materials	Aluminium / Polycarbonate



\*\*US product only. Not available in Canada. Fit 20 24V is a projector for the Minimal Track system. Cylindrical geometry and essential forms, it stands out for its minimalistic looking and its functionality as it can be orientated in any direction. The black perimeter around its mouth highlights its anti-glare vocation.



POLAR DIAGRAM

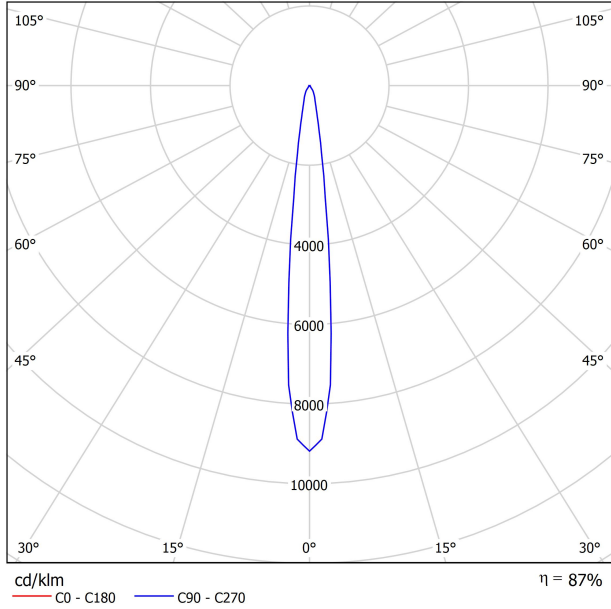

CONICAL DIAGRAM

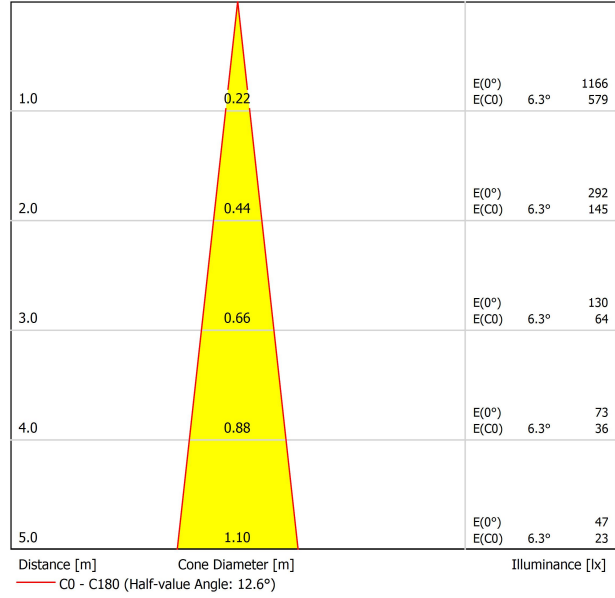

24V SYSTEM

# MINIMAL TRACK

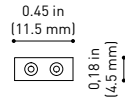
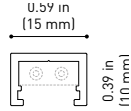
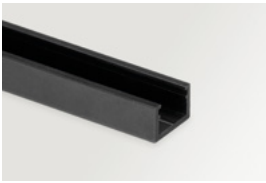

**MINIMAL TRACK 24V Profile 2m UL** U384-02-00- | N |

2m = 78.74in

**MINIMAL TRACK 24V Rubber Cable n x 1m UL** U384-00-01- | N |

n = Total Length of System  
1m = 39.37in

24V | Max. 4A

**MINIMAL TRACK 24V Corner 90° 1 Plane UL**

U384-00-02- | N |

Cable Length = 1.38in (35mm)

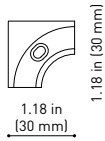

**MINIMAL TRACK 24V Corner 90° 1 Plane Rounded UL**

U384-00-03- | N |

Cable Length = 1.38in (35mm)

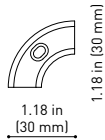

**MINIMAL TRACK 24V Corner 90° 2 Planes UL**

Cable Length = 3.94in (100mm)

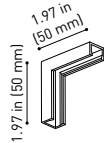

**MINIMAL TRACK 24V End Cap UL**

U384-00-05- | N |



**MINIMAL TRACK 24V Connection Box UL**

U384-00-06- | N |

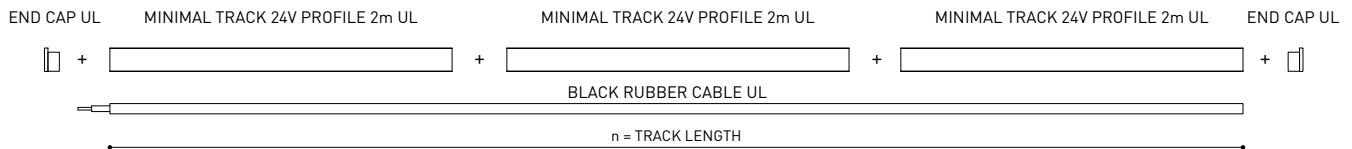
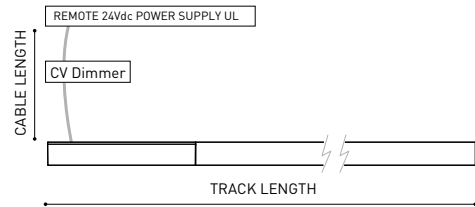

COLOUR | N ■ |

DIM OPTIONS PLEASE CONSULT

INSTALLATION GUIDE  
<https://youtu.be/AqTIsTcSoGA>



24V SYSTEM

# MINIMAL TRACK SUSPENSION

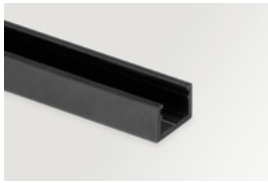

**MINIMAL TRACK 24V Suspension UL**

**Profile 2m**

U384-02-00- | N |

**Profile 2m Initial feed kit UL**

U400-02-10- | N |

**Profile 2m Middle feed kit UL\***

U400-02-20- | N |

\* Unidirectional Middle Feed  
2m = 78.74in

**MINIMAL TRACK 24V Suspension Corner 90° UL**

U400-00-03- | N |

Cable Length = 3.35in (85mm)

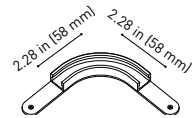
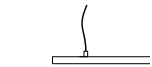

**MINIMAL TRACK 24V Suspension UL**

**Rubber Cable n x 1m UL**

U400-00-01- | N |

n = Total Length of System  
1m = 39.37in

24V | Max. 4A

**MINIMAL TRACK 24V Suspension Straight Joiner UL**

U400-00-02- | N |

**MINIMAL TRACK 24V Suspension Kit UL**

U400-02-04- | N |

**MINIMAL TRACK 24V Suspension End Caps UL**

U400-00-05- | N |

Two End Caps Included

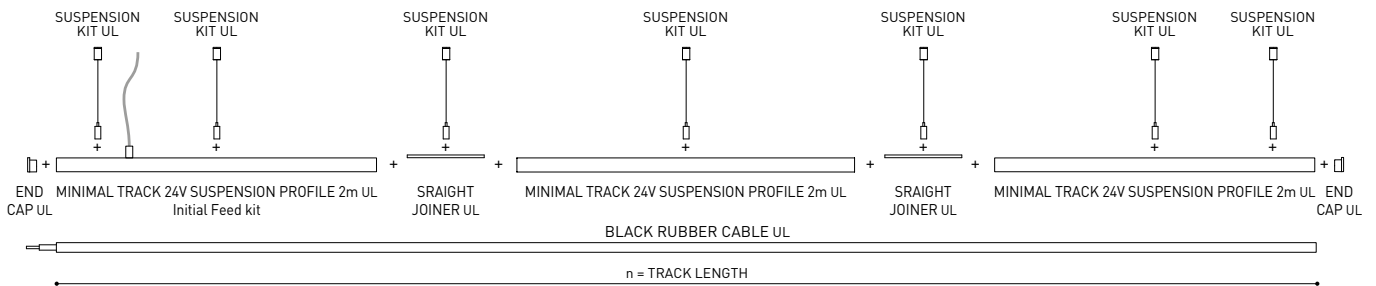
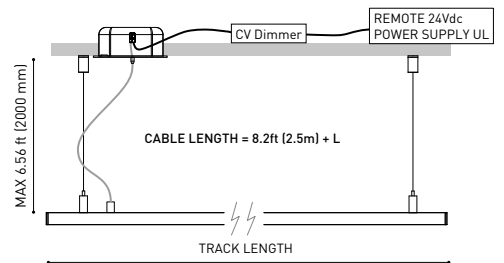
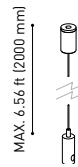
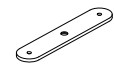

COLOUR | N ■ |

DIM OPTIONS PLEASE CONSULT

24V SYSTEM

MINIMAL TRACK SURFACE & SUSPENSION

	P	V	D (A x B x C)	
<b>MINIMAL TRACK 24V Remote Power Supply UL</b>	<b>U384-00-07</b>	100W	24V	8.16 x 2.97 x 1.30 in 207.2 x 75.4 x 33 mm

120 & 277 V | 50/60 Hz | NO DIM

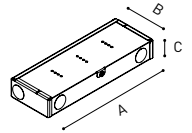

	P	V	D (A x B x C)	
<b>MINIMAL TRACK 24V Dimmable Power Supply UL*</b>	<b>U010-00-01</b>	60W	24V	5.83 x 1.68 x 1 in 148.2 x 42.6 x 25.4 mm
	<b>U010-00-02</b>	100W	24V	9.5 x 1.57 x 1 in 241.3 x 39.9 x 25.4 mm

120 & 277 V | 50/60 Hz | 0-10 V

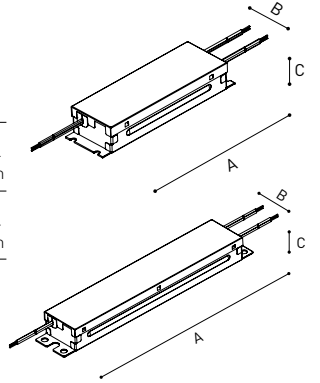

	P	V	D (A x B x C)	
<b>MINIMAL TRACK 24V Constant Voltage Dimmer</b>	<b>U010-00-00</b>	144W	24V	2.86 x 1.18 x 0.71 in 72.6 x 30 x 18 mm

24 V | CASAMBI

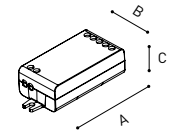

UL DROP VOLTAGE TABLE

POWER	CABLE SECTION	CABLE LENGTH			
		<16.40 ft <5 m	<32.80 ft <10 m	<65.62 ft <20 m	<98.43 ft <30 m
60 W	AWG18	98.43 ft 30 m	98.43 ft 30 m	65.62 ft 20 m	32.80 ft 10 m
	AWG16	98.43 ft 30 m	98.43 ft 30 m	98.43 ft 30 m	65.62 ft 20 m
96 W	AWG18	65.62 ft 20 m	32.80 ft 10 m	X	X
	AWG16	65.62 ft 20 m	65.62 ft 20 m	32.80 ft 10 m	X

PHASE CUT AND DMX DIM OPTIONS PLEASE CONSLT | \*POWER SUPPLY REQUIRES AN ENCLOSURE FOR INSTALLATION. ENCLOSURE NOT PROVIDED